

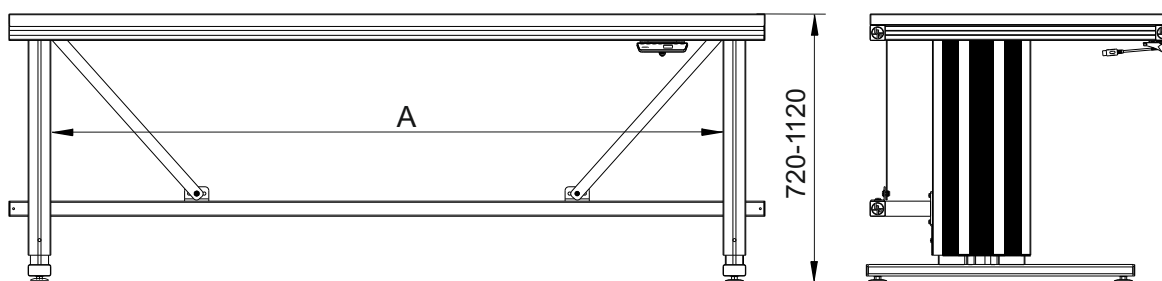

SYSTEM FLEX basic table with electric height adjustment



Ref.:	73000600	73000601	
Width B (mm):	1200	1200	
Depth T (mm):	800	800	
Height (mm):	720 - 1120	720 - 1120	
Inner width A (mm)	978	978	
Colour combination	RAL 9006 / 3003	RAL 9006 / 5010	
Net weight (kg)	59.80	59.80	

Description:

The HR profile tube uses the advantages of a sturdy steel construction and creates a totally innovative and exceedingly flexible concept.

The first packing table that has been certified by the German interest group of back-training teachers as an ergonomic product.

Daisy-chaining, integration and adaptation options offer countless possibilities from single workplaces up to complete packaging lines.

- tubular steel frame 40 x 40 mm
- worktop 30 mm, light grey, melamine resin coating
- table frame powder-coated white aluminium RAL 9006,
- functional struts ruby red RAL 3003 or Gentian blue RAL 5010
- height adjustment 720 - 1120 mm, infinitely via electric motor
- extensive range of accessories
- max. load capacity 220 kg



SYSTEM FLEX basic table with electric height adjustment

Ref.: basic table	73000600	73000601
Pos.1 table top	73200010 Standard	73200010 Standard
Pos.2 table top	73200300 ESD-conductive	73200300 ESD-conductive
Pos.3 table top	73202400 beech-multiplex	73202400 beech-multiplex
Pos.4 table top	73202700 Solid beech	73202700 Solid beech

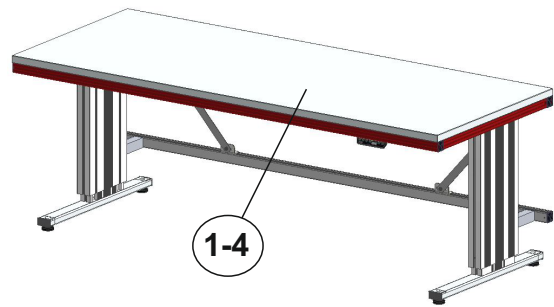

Logistic information

Ref.: 73000600 / 73000601

SYSTEM FLEX basic table with electric height adjustment

Ref.:	73000600	73000601		
Number of packets:	1	1		
EAN:	4030177046422	4030177046453		
Size WxDxH (mm):				
Weight (kg):				

examples: optional accessories

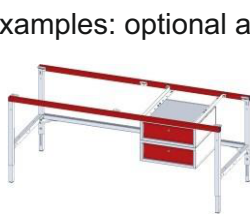
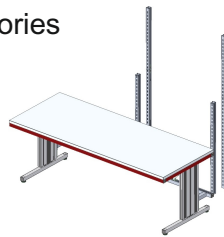
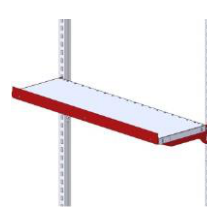
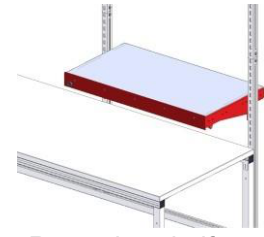
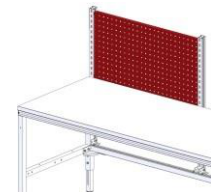
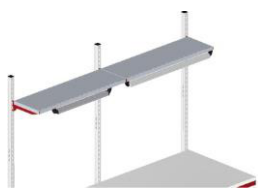
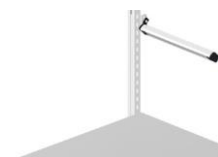
Single drawer
Ref.: 73314500/01
Supplement drawer
Ref.: 73314600/01HR- mounting profile short
Ref.: 73309200
HR- mounting profile long
Ref.: 73308000Shelves
Ref.: 73306900 -
73307600Retracting shelf
Ref.: 73303600/01
Ref.: 73303700/01Keyboard and mouse
platform with folding arm
Ref.: 509201Shelf with retracting
keyboard tray
Ref.: 73316500/01
Ref.: 73316600/01Cable tray
Ref.: 73600088
Ref.: 73600026Perforated back panel
Ref.: 733022../23..
Ref.: 733034..
Ref.: 733055../59..
Ref.: 733060..Workplace lighting LED
Ref.: 73315610
Ref.: 73315710Additional workplace
lighting LED
Ref.: 73315810Thin Client holder
Ref.: 73308300TFT folding arm
Ref.: 509203