

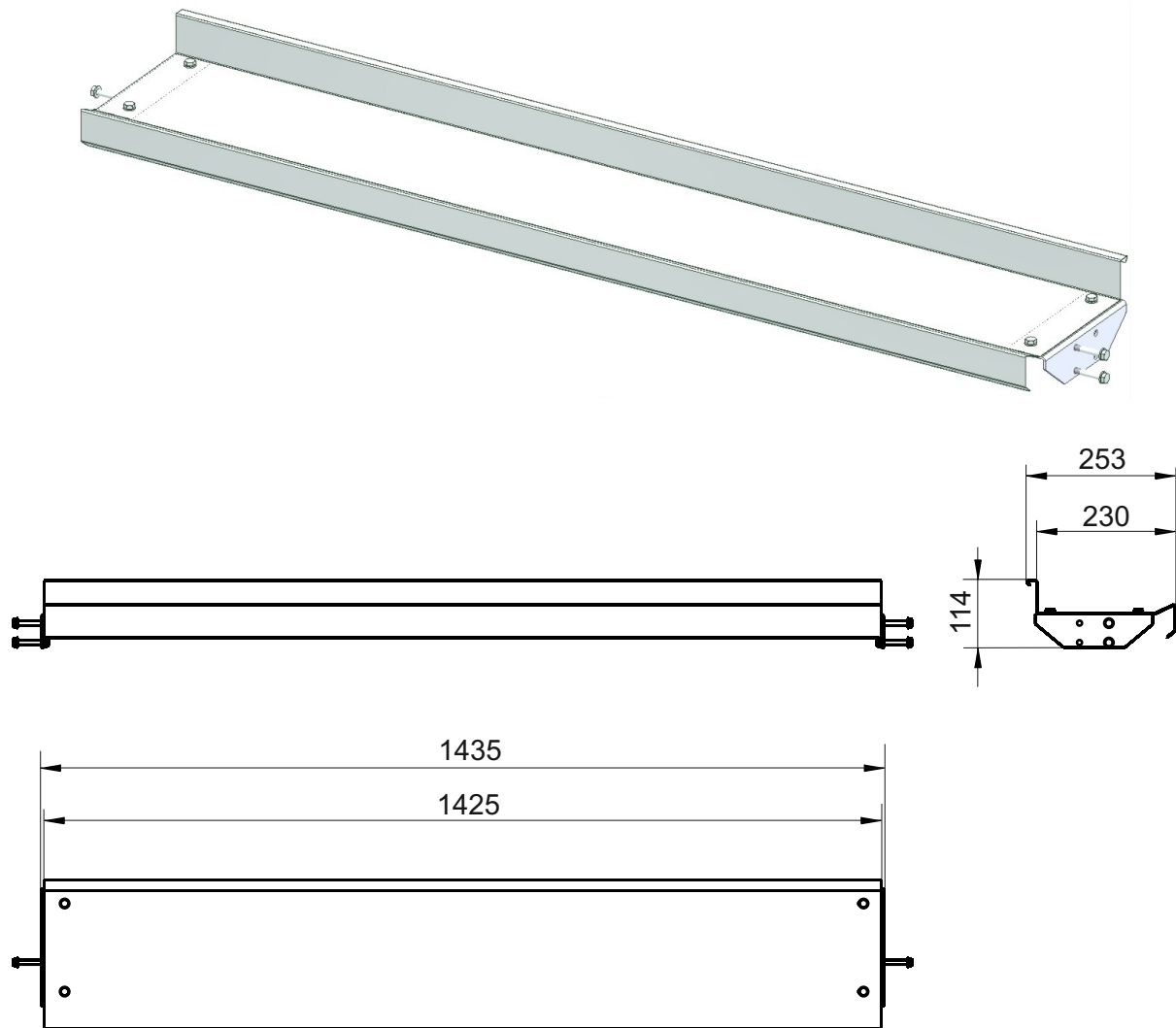

SYSTEM BASIC Document shelf



Ref.	700060		
Width (mm):	1435		
Depth (mm):	253		
Height (mm):	114		
Usable area (mm)	1425 x 230		
Net weight (kg):	6.00		

Description:  
Document shelf

- Galvanised sheet steel
- For attachment to the uprights
- Surface load capacity max. 50 kg



**SYSTEM BASIC Document shelf**

Ref.	<b>700060</b>			
Number of packets:	1			
EAN:	4030177057138			
Size WxDxH (mm):	270x1480x70			
Weight (kg):	5.90			

Examples:  
Optional accessories

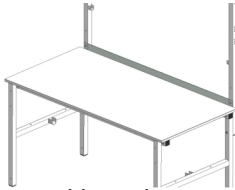

Backboard  
Ref. 700040



Uprights  
Ref. 700030

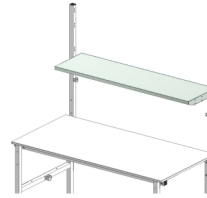

Storage shelf  
Ref. 700070



Add-on storage rack  
Ref. 700050



Bottom shelf  
Ref. 700100



Drawer,  
lockable  
Ref. 700120

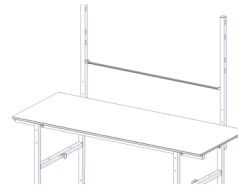

Spindle between  
the uprights  
Ref. 700140



Spindle underneath the  
table (between feet)  
Ref. 700150

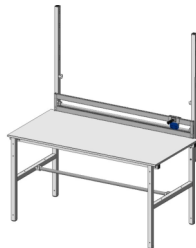

Add-on cutter  
incl. spindle  
Ref. 700090

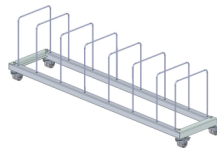

Undertable cardboard  
storage rack  
Ref. 700080



Side table  
Ref. 700020

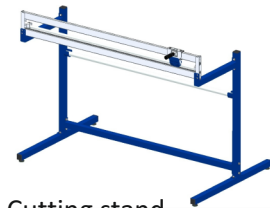

Cutting stand,  
horizontal  
Ref. 700130



PC holder with  
strap  
Ref. 308100



Container, mobile  
Ref. 700110



TFT monitor holder,  
Vesa 75/100  
Ref. 228120



Drawer unit  
Ref. 3010



Cupboard unit  
Ref. 3011