

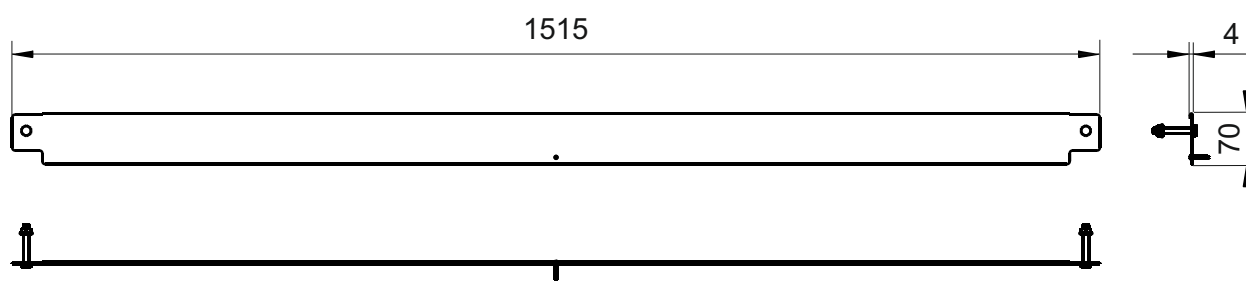

SYSTEM BASIC Backboard

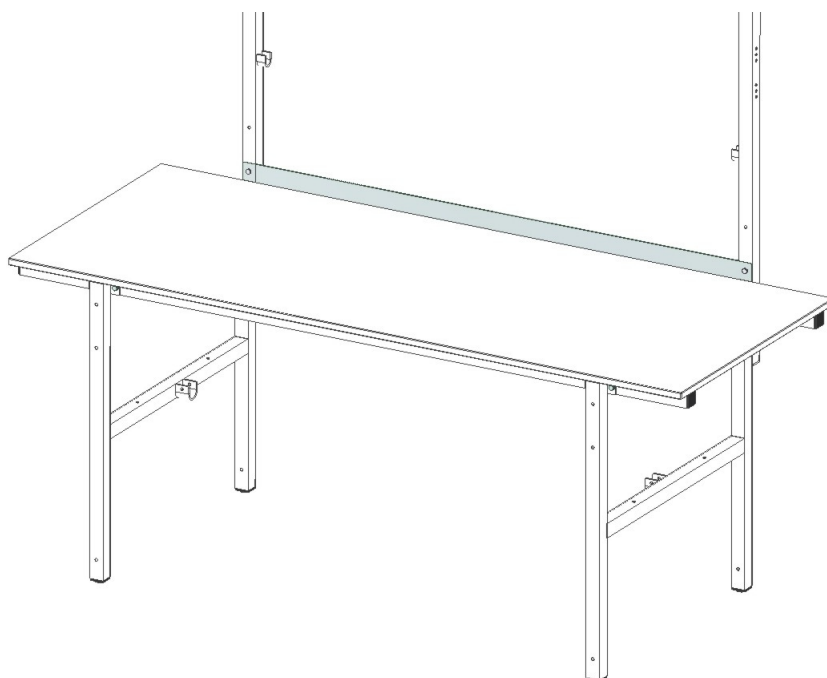

Ref.	700040		
Width (mm):	1515		
Depth (mm):	4		
Height (mm):	70		
Net Weight (kg):	1.20		

Description:
Backboard

- For attachment to the uprights
- Galvanised sheet steel



Ref.	700040			
Number of packet:	1			
EAN:	4030177057114			
Size WxDxH (mm):	80x1530x40			
Weight (kg):	1.50			

Examples:
Optional accessories



Bottom shelf
Ref. 700100



Uprights
Ref. 700030

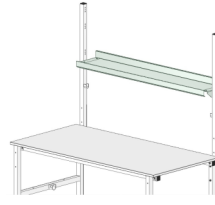

Document shelf
Ref. 700060

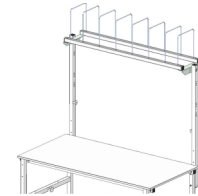

Add-on storage rack
Ref. 700050

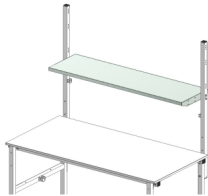

Storage shelf
Ref. 700070



Drawer,
lockable
Ref. 700120

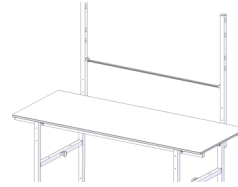

Spindle between
the uprights
Ref. 700140

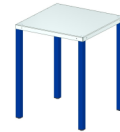

Side table
Ref. 700020

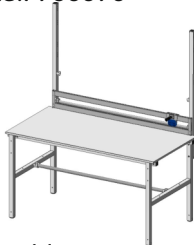

Add-on cutter
incl. spindle
Ref. 700090

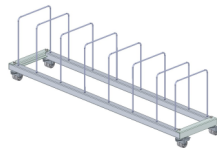

Undertable cardboard
storage rack
Ref. 700080



Spindle underneath the
table (between feet)
Ref. 700150

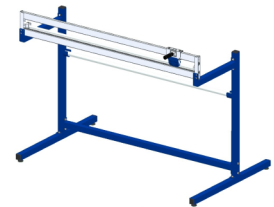

Cutter stand,
horizontal
Ref. 700130



PC holder with
strap
Ref. 308100



Container, mobile
Ref. 700110



TFT monitor holder,
Vesa 75/100
Ref. 228120



Drawer unit
Ref. 3010



Cupboard unit
Ref. 3011