

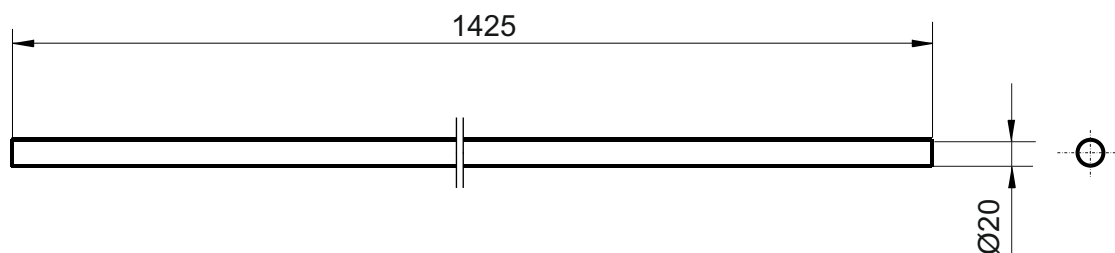
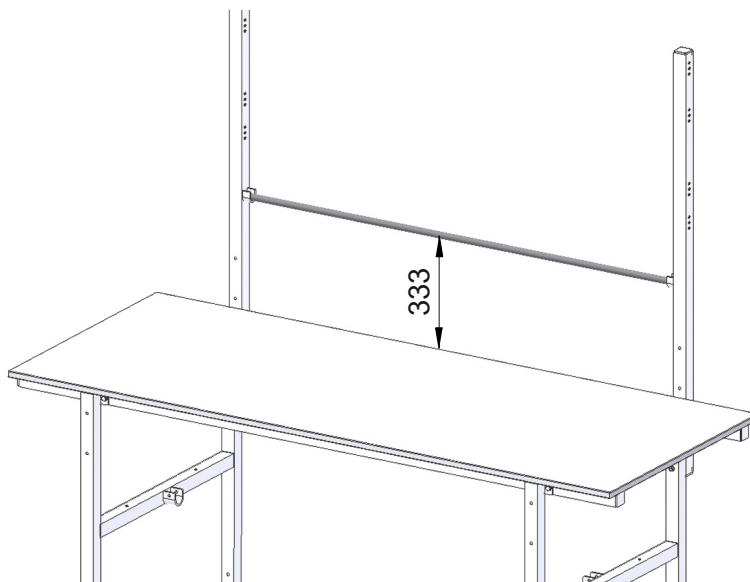

**SYSTEM BASIC Spindle between uprights**

Ref.	700140		
Width W (mm):	1425		
Depth D (mm):	20		
Height H (mm):	20		
above the table (mm)	333		
Net Weight (kg):	0.50		

Description:  
 Spindle between the uprights

- for mounting material rolls
- for light rolls
- max. roll diameter 300mm
- Load capacity max. 20 kg



**SYSTEM BASIC Spindle between uprights**

Ref.	<b>700140</b>			
Number of packets:	1			
EAN:	4030177060527			
Size WxDxH (mm):	1425x20x20			
Weight (kg):	0.60			

Examples:  
Optional accessories

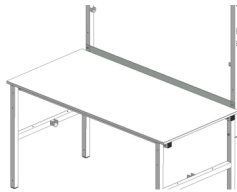

Backboard  
Ref. 700040

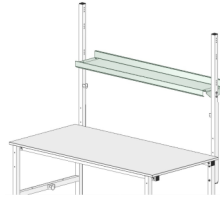

Document shelf  
Ref. 700060

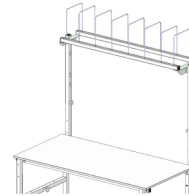

Add-on storage rack  
Ref. 700050



Bottom shelf  
Ref. 700100



Drawer,  
lockable  
Ref. 700120

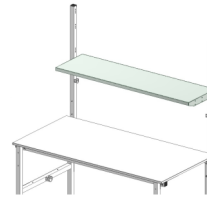

Storage shelf  
Ref. 700070

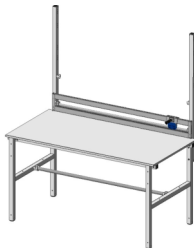

Add-on cutter  
incl. spindle  
Ref. 700090

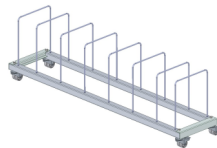

Undertable cardboard  
storage rack  
Ref. 700080



Spindle underneath the  
table (between feet)  
Ref. 700150



PC holder with  
strap  
Ref. 308100



Container, mobile  
Ref. 700110



Side table  
Ref. 700020

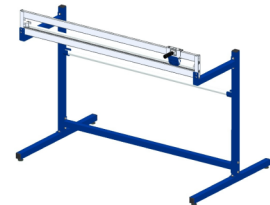

Cutter stand,  
horizontal  
Ref. 700130



TFT monitor holder,  
Vesa 75/100  
Ref. 228120



Drawer unit  
Ref. 3010



Cupboard unit  
Ref. 3011