

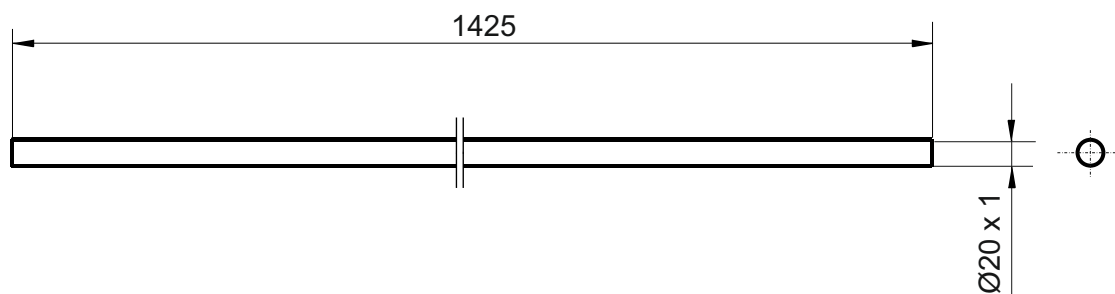

SYSTEM BASIC Achse zwischen Holme

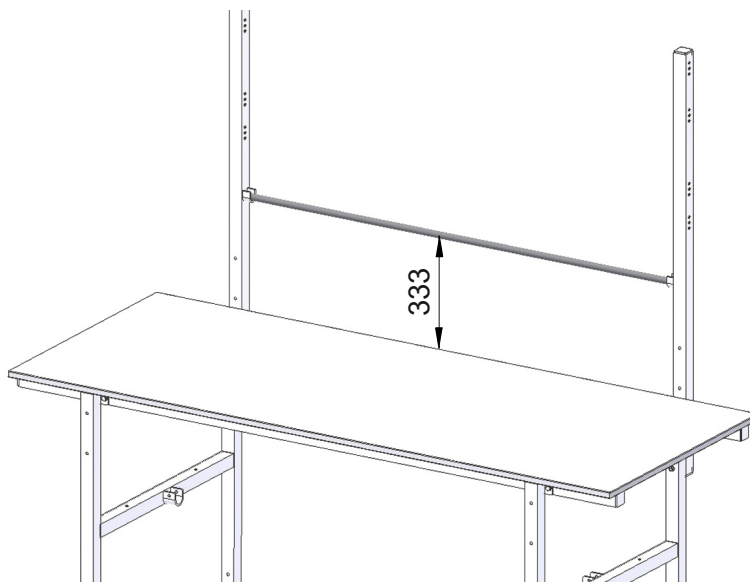

Best.-Nr.	700140		
Breite (mm):	1425		
Tiefe (mm):	20		
Höhe (mm):	20		
über Tisch (mm)	333		
Nettogewicht (kg):	0.50		

Beschreibung:

Achse zwischen den Holmen

- für leichtes Rollenmaterial über dem Tisch
- max. Rollendurchmesser 300mm
- Tragfähigkeit 20 kg



SYSTEM BASIC Achse zwischen Holme

Art.-Nr.:	700140			
Anzahl Pakete:	1			
EAN:	4030177060527			
Maße BxTxH (mm):	1425x20x20			
Gewicht (kg):	0.60			

Beispiele:
Optionales Zubehör

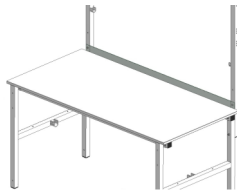

Rückwandbord
Best.-Nr.: 700040

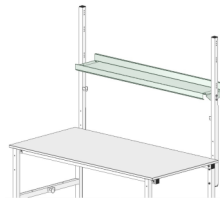

Formularablage
Best.-Nr.: 700060

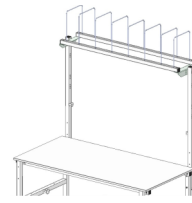

Anbaumagazin
Best.-Nr.: 700050



Zwischenboden
Best.-Nr.: 700100



Schublade,
verschließbar
Best.-Nr.: 700120



Ablagebord
Best.-Nr.: 700070

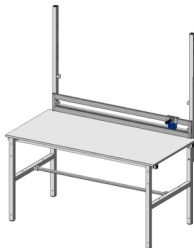

Anbauschneidvorrichtung
inkl. Untertischachse
Best.-Nr.: 700090

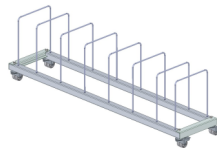

Untertisch
Kartonmagazin
Best.-Nr.: 700080



Achse unter dem Tisch
zwischen den Füßen
Best.-Nr.: 700150



PC-Halterung mit
Gurtband
Best.-Nr.: 308100



Container
Best.-Nr.: 700110



Beistelltisch
Best.-Nr.: 700020

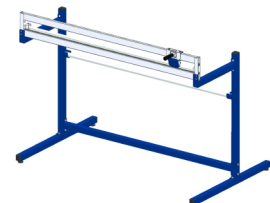

Schneidständer,
waagrecht
Best.-Nr.: 700130



TFT Halter
VESA 75/100
Best.-Nr.: 228120



Schubladeneinheit
Best.-Nr.: 3010



Schrankeinheit
Best.-Nr.: 3011