

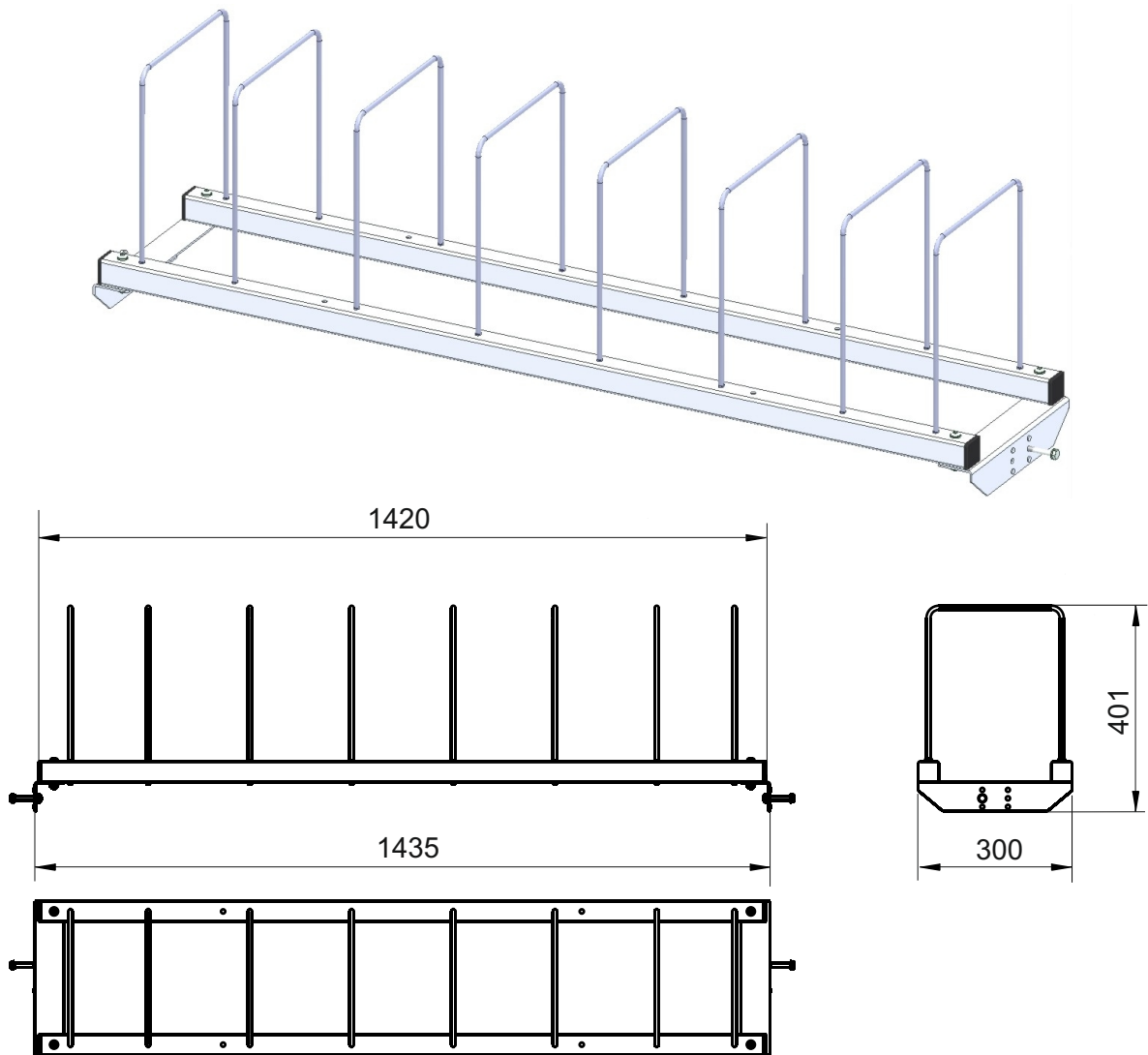

SYSTEM BASIC Add-on storage rack



Ref.	700050		
Width (mm):	1435		
Depth (mm):	300		
Height (mm):	401		
Usable area (mm)	1420 x 300		
Net Weight (kg):	11.00		

Description:
Add-on storage rack

- Square tubes
- Powder-coated steel parts: light gray RAL 7035
- Incl. eight dividers
- Surface load capacity max. 50 kg



Ref.	700050			
Number of packet:	1			
EAN:	4030177057121			
Size WxDxH (mm):	320x1450x50			
Weight (kg):	12.00			

Examples:
 Optional accessories

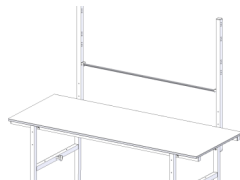

Spindle between the uprights
 Ref. 700140



Uprights
 Ref. 700030

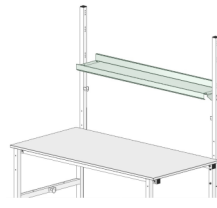

Document shelf
 Ref. 700060

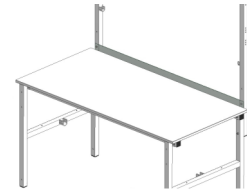

Backboard
 Ref. 700040



Bottom shelf
 Ref. 700100



Drawer, lockable
 Ref. 700120

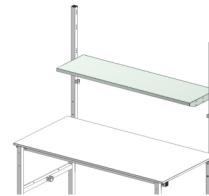

Storage shelf
 Ref. 700070



Spindle underneath the table (between feet)
 Ref. 700150

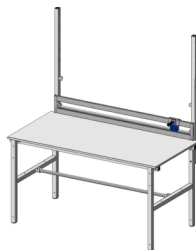

Add-on cutter incl. spindle
 Ref. 700090

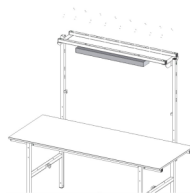

Workplace lighting
 Ref. 207003

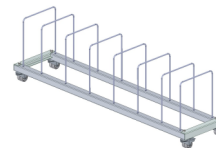

Undertable cardboard storage rack
 Ref. 700080

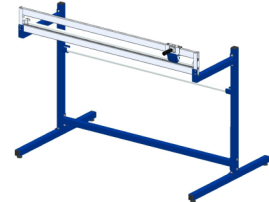

Cutter stand, horizontal
 Ref. 700130



PC holder with strap
 Ref. 308100



Container, mobile
 Ref. 700110



TFT monitor holder, Vesa 75/100
 Ref. 228120



Drawer unit
 Ref. 3010



Cupboard unit
 Ref.: 3011