

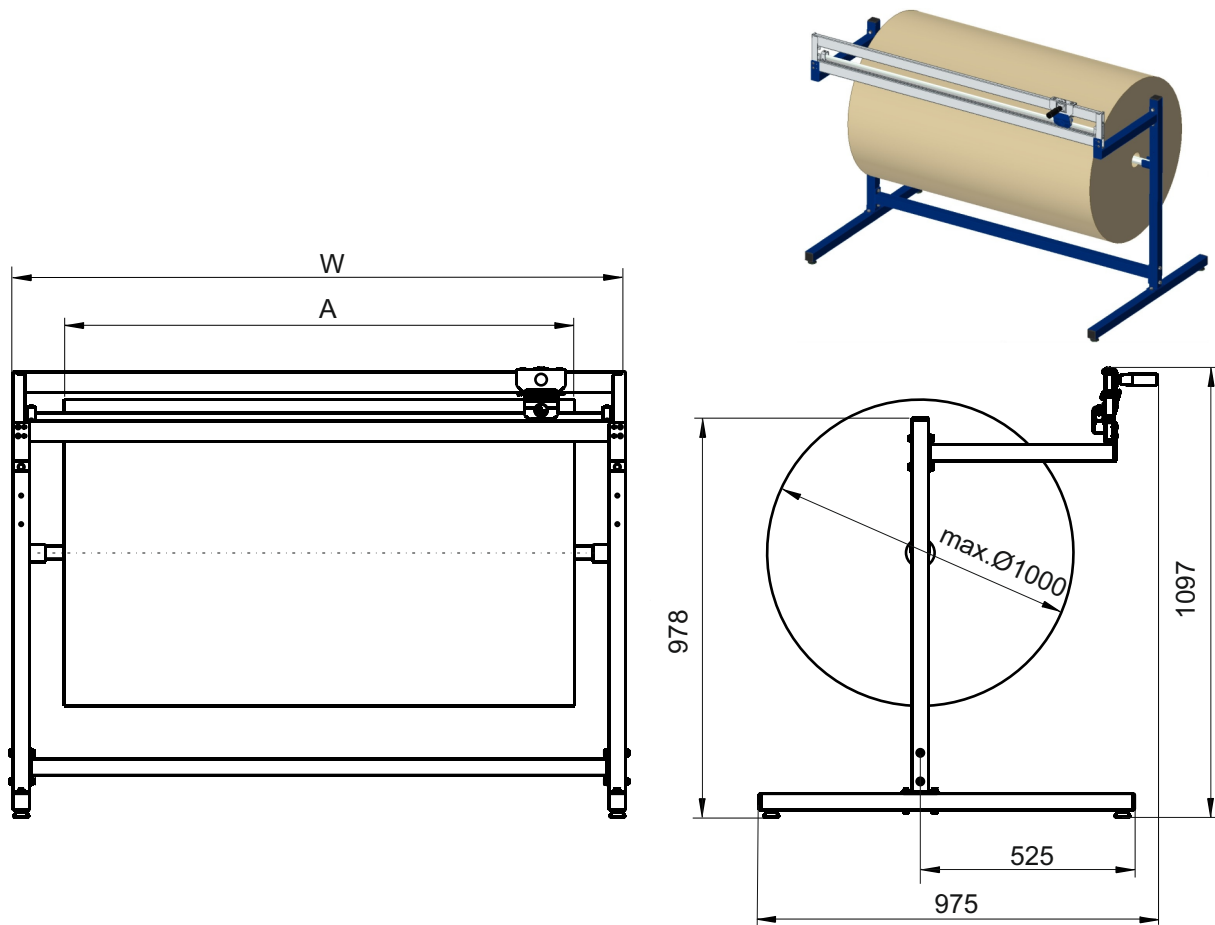

## SYSTEM BASIC Cutter stand, horizontal



Ref.	<b>700130</b>		
max. roll width A (mm)	1250		
max. roll-diameter (mm)	1000		
Width W (mm):	1500		
Depth (mm):	975		
Height (mm):	1097		
max. roll weight (kg):	100.00		
Net weight (kg):	24.00		

**Description:**

For use either as a stand-alone cutting station or right next to the packing workplace. The machinery quickly pays for itself since roll material is cheaper than cuttings. Not only that, but it also makes the dangerous and time-consuming handling of knives and scissors superfluous.

The cutter cartridge can be exchanged without any effort.

- max. roll width 1250 mm
- max. roll weight 50 Kg
- max. roll diameter 1000 mm
- with blades for foam, air bubble film, etc.
- without cones and clamp rings for adjusting roll and spindle



**SYSTEM BASIC Cutter stand, horizontal**



Cutting slide (complete)  
Ref. 62502B

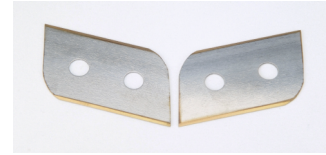

Blade bipartite for cassette  
for films, bubble foils etc.  
(without fixing plate)  
Ref. 6250200



Set of sliding shoes  
for cutting carriage  
Ref. 63525



Cassette complete with  
blades, bipartite  
Ref. 62503B

**Logistic information**

Ref. 700130

**SYSTEM BASIC Cutter stand, horizontal**

Ref.	<b>700130</b>			
Number of packets:	1			
EAN:	4030177057244			
Size WxDxH (mm):	1650x300x140			
Weight (kg):	25.00			

**Examples:  
Optional accessories**

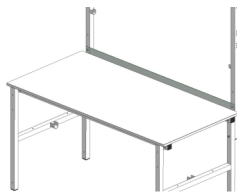

Backboard  
Ref. 700040



Uprights  
Ref. 700030

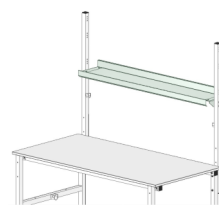

Document shelf  
Ref. 700060

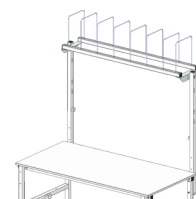

Add-on storage rack  
Ref. 700050



Bottom shelf  
Ref. 700100

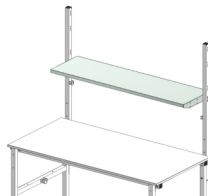

Storage shelf  
Ref. 700070



Drawer,  
lockable  
Ref. 700120



Side table  
Ref. 700020

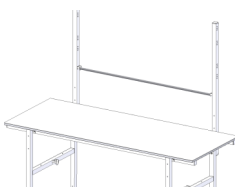

Spindle between  
the uprights  
Ref. 700140

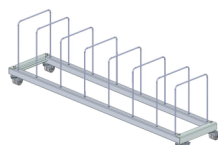

Undertable cardboard  
storage rack  
Ref. 700080



Spindle underneath the  
table (between feet)  
Ref. 700150